

QM48T50015 DC-DC Converter Data Sheet

36-75 VDC Input; 1.5 VDC @ 50A Output



The **QmaX™ Series** of high current single output DC/DC converters from Power-One sets new standards for thermal performance and power density in the quarter brick package.

The **50A QM48** converters of the **QmaX™ Series** provide thermal performance in high temperature environments that is comparable to or exceeds the industry's leading 50A half bricks. This is accomplished through the use of patent pending circuit, packaging and processing techniques to achieve ultra-high efficiency, excellent thermal management and a very low body profile.

The **QM48T50** converters have a power density more than twice that of competitors' 50A half bricks. Over 2 square inches of board space can be saved for every slot in which a 50A half brick is replaced with a **QM48T50** converter from Power-One.

Low body profile and the preclusion of heat sinks minimize impedance to system airflow, thus enhancing cooling for downstream devices. The use of 100% automation for assembly, coupled with Power-One's advanced electric and thermal design, results in a product with extremely high reliability.

Operating from a 36-75 V input, the **QmaX™ Series** converters provide standard output voltage for 1.5 V. Output can be trimmed from -20% to +10% of the nominal output voltage, thus providing outstanding design flexibility.

Applications

- Telecommunications
- Data communications
- Wireless
- Servers

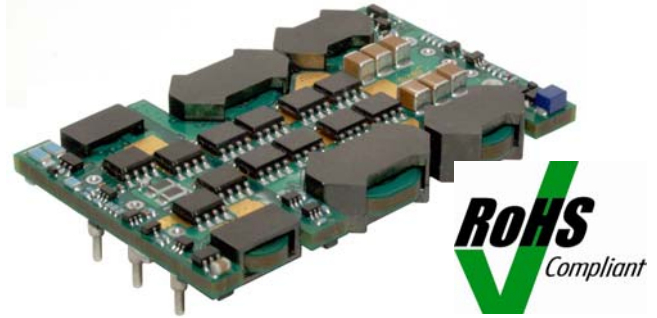

QM48T50015 Converter

Features

- **RoHS lead-free solder and lead-solder-exempted products are available**
- **Delivers up to 50 A @ 1.5 V (75 W)**
- **Industry-standard quarter brick pinout**
- **Higher current capability at 70°C than most competitors' 50 A half bricks**
- **On-board input differential LC-filter**
- **High efficiency – no heat sink required**
- **Start up into pre-biased output**
- **No minimum load required**
- **Lowest profile in industry: 0.31" [7.9 mm]**
- **Lowest weight in industry: 1.1 oz [31.5 g] typical**
- **Meets Basic Insulation requirements of EN60950**
- **Withstands 100 V input transient for 100 ms**
- Fixed frequency operation
- Fully protected
- Remote output sense
- Output voltage trim range: +10%/-20% with Industry-standard trim equations
- High reliability: MTBF of 2.6 million hours, calculated per Telcordia TR-332, Method I Case 1
- Positive or negative logic ON/OFF option
- UL 60950 recognized in US and Canada and DEMKO certified per IEC/EN 60950
- Meets conducted emissions requirements of FCC Class B and EN 55022 Class B with external filter
- All materials meet UL94, V-0 flammability rating

QM48T50015 DC-DC Converter Data Sheet

36-75 VDC Input; 1.5 VDC @ 50A Output



Electrical Specifications

Conditions: $T_A=25^{\circ}\text{C}$, Airflow=300 LFM (1.5 m/s), $V_{in}=48\text{ Vdc}$, All output voltages, unless otherwise specified.

PARAMETER	NOTES	MIN	TYP	MAX	UNITS
ABSOLUTE MAXIMUM RATINGS					
Input Voltage	Continuous	0		80	Vdc
Operating Ambient Temperature		-40		85	$^{\circ}\text{C}$
Storage Temperature		-55		125	$^{\circ}\text{C}$
INPUT CHARACTERISTICS					
Operating Input Voltage Range		36	48	75	Vdc
Input Under Voltage Lockout	Non-latching				
Turn-on Threshold		33	34	35	Vdc
Turn-off Threshold		31	32	33	Vdc
Input Voltage Transient	100 ms			100	Vdc
ISOLATION CHARACTERISTICS					
I/O Isolation		2000			Vdc
Isolation Capacitance			1.4		nF
Isolation Resistance		10			M Ω
FEATURE CHARACTERISTICS					
Switching Frequency			415		kHz
Output Voltage Trim Range ¹	Industry-std. equations	-20		+10	%
Remote Sense Compensation ¹	Percent of $V_{OUT(NOM)}$			+10	%
Output Over-Voltage Protection	Non-latching	117	128	140	%
Auto-Restart Period	Applies to all protection features		100		ms
Turn-On Time			4		ms
ON/OFF Control (Positive Logic)					
Converter Off		-20		0.8	Vdc
Converter On		2.4		20	Vdc
ON/OFF Control (Negative Logic)					
Converter Off		2.4		20	Vdc
Converter On		-20		0.8	Vdc

Additional Notes:

- V_{out} can be increased up to 10% via the sense leads or up to 10% via the trim function, however total output voltage trim from all sources should not exceed 10% of $V_{OUT(NOM)}$, in order to insure specified operation of over-voltage protection circuitry.

QM48T50015 DC-DC Converter Data Sheet
36-75 VDC Input; 1.5 VDC @ 50A Output



Electrical Specifications (continued)

Conditions: $T_A=25^{\circ}\text{C}$, Airflow=300 LFM (1.5 m/s), $V_{in}=48\text{ Vdc}$, $V_{out}=1.5\text{ Vdc}$ unless otherwise specified.

PARAMETER	NOTES	MIN	TYP	MAX	UNITS
INPUT CHARACTERISTICS					
Maximum Input Current	50 Adc, 1.5 Vdc Out @ 36 Vdc In			2.5	Adc
Input Stand-by Current	$V_{in} = 48\text{ V}$, converter disabled		3		mAdc
Input No Load Current (0 load on the output)	$V_{in} = 48\text{ V}$, converter enabled		42		mAdc
Input Reflected-Ripple Current	25MHz bandwidth		7.5		$\text{mA}_{\text{PK-PK}}$
Input Voltage Ripple Rejection	120Hz		TBD		dB
OUTPUT CHARACTERISTICS					
Output Voltage Set Point (no load)		1.485	1.500	1.515	Vdc
Output Regulation					
Over Line			± 2	± 4	mV
Over Load			± 2	± 4	mV
Output Voltage Range	Over line, load and temperature ²	1.477		1.523	Vdc
Output Ripple and Noise - 25MHz bandwidth	Full load + 10 μF tantalum + 1 μF ceramic		30	50	$\text{mV}_{\text{PK-PK}}$
External Load Capacitance	Plus full load (resistive)			40,000	μF
Output Current Range		0		50	Adc
Current Limit Inception	Non-latching		59	64	Adc
Peak Short-Circuit Current	Non-latching. Short=10m Ω .			72	A
RMS Short-Circuit Current	Non-latching			18	Arms
DYNAMIC RESPONSE					
Load Change 25% of Iout Max, di/dt = 1 A/ μS	$C_o = 470\text{ }\mu\text{F}$ tantalum + 1 μF ceramic		150		mV
Setting Time to 1%			200		μs
EFFICIENCY					
100% Load			84		%
50% Load			88		%

Additional Notes: 2. -40°C to 85°C



Operation

Input and Output Impedance

These power converters have been designed to be stable with no external capacitors when used in low inductance input and output circuits.

However, in many applications, the inductance associated with the distribution from the power source to the input of the converter can affect the stability of the converter. The addition of a 33 μF electrolytic capacitor with an ESR $< 1 \Omega$ across the input helps ensure stability of the converter. In many applications, the user has to use decoupling capacitance at the load. The power converter will exhibit stable operation with external load capacitance up to 40,000 μF .

ON/OFF (Pin 2)

The ON/OFF pin is used to turn the power converter on or off remotely via a system signal. There are two remote control options available, positive logic and negative logic and both are referenced to $V_{in(-)}$. Typical connections are shown in Fig. A.

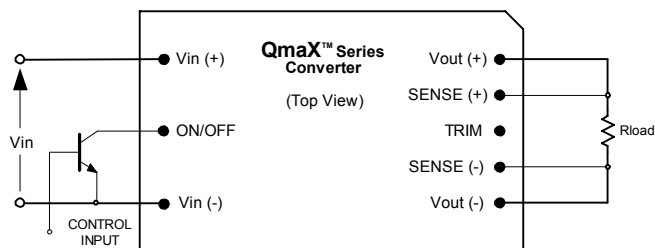

Fig. A: Circuit configuration for ON/OFF function.

The positive logic version turns on when the ON/OFF pin is at a logic high and turns off when at a logic low. The converter is on when the ON/OFF pin is left open.

The negative logic version turns on when the pin is at a logic low and turns off when the pin is at a logic high. The ON/OFF pin can be hard wired directly to $V_{in(-)}$ to enable automatic power up of the converter without the need of an external control signal.

ON/OFF pin is internally pulled-up to 5 V through a resistor. A mechanical switch, open collector transistor, or FET can be used to drive the input of the ON/OFF pin. The device must be capable of sinking up to 0.2 mA at a low level voltage of $\leq 0.8 \text{ V}$. An external voltage source ($\pm 20 \text{ V}$ maximum) may be connected directly to the ON/OFF input, in which

case it must be capable of sourcing or sinking up to 1 mA depending on the signal polarity. See the Start-up Information section for system timing waveforms associated with use of the ON/OFF pin.

Remote Sense (Pins 5 and 7)

The remote sense feature of the converter compensates for voltage drops occurring between the output pins of the converter and the load. The SENSE(-) (Pin 5) and SENSE(+) (Pin 7) pins should be connected at the load or at the point where regulation is required (see Fig. B).

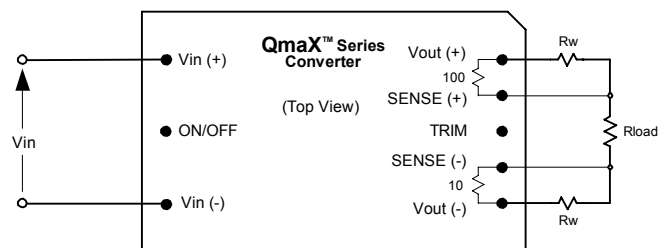

Fig. B: Remote sense circuit configuration.

If remote sensing is not required, the SENSE(-) pin must be connected to the $V_{out(-)}$ pin (Pin 4), and the SENSE(+) pin must be connected to the $V_{out(+)}$ pin (Pin 8) to ensure the converter will regulate at the specified output voltage. If these connections are not made, the converter will deliver an output voltage that is slightly higher than the specified value.

Because the sense leads carry minimal current, large traces on the end-user board are not required. However, sense traces should be located close to a ground plane to minimize system noise and insure optimum performance. When wiring discretely, twisted pair wires should be used to connect the sense lines to the load to reduce susceptibility to noise.

The converter's output over-voltage protection (OVP) senses the voltage across $V_{out(+)}$ and $V_{out(-)}$, and not across the sense lines, so the resistance (and resulting voltage drop) between the output pins of the converter and the load should be minimized to prevent unwanted triggering of the OVP.

When utilizing the remote sense feature, care must be taken not to exceed the maximum allowable output power capability of the converter, equal to the product of the nominal output voltage and the allowable output current for the given conditions.

When using remote sense, the output voltage at the converter can be increased by as much as 10% above the nominal rating in order to maintain the required voltage

QM48T50015 DC-DC Converter Data Sheet

36-75 VDC Input; 1.5 VDC @ 50A Output



across the load. Therefore, the designer must, if necessary, decrease the maximum current (originally obtained from the derating curves) by the same percentage to ensure the converter's actual output power remains at or below the maximum allowable output power.

Output Voltage Adjust /TRIM (Pin 6)

The output voltage can be adjusted up 10% or down 20% for $V_{out} \geq 1.5$ V, relative to the rated output voltage by the addition of an externally connected resistor.

The TRIM pin should be left open if trimming is not being used. To minimize noise pickup, a 0.1 μ F capacitor is connected internally between the TRIM and SENSE(-) pins.

To increase the output voltage, refer to Fig. C. A trim resistor, R_{T-INCR} , should be connected between the TRIM (Pin 6) and SENSE(+) (Pin 7), with a value of:

$$R_{T-INCR} = \frac{5.11(100 + \Delta)V_{O-NOM} - 626}{1.225\Delta} - 10.22 \text{ [k}\Omega\text{]}$$

where,

R_{T-INCR} = Required value of trim-up resistor k Ω

V_{O-NOM} = Nominal value of output voltage [V]

$$\Delta = \frac{(V_{O-REQ} - V_{O-NOM})}{V_{O-NOM}} \times 100 \text{ [%]}$$

V_{O-REQ} = Desired (trimmed) output voltage [V].

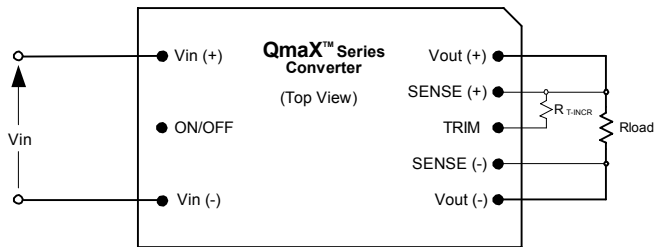

Fig. C: Configuration for increasing output voltage.

When trimming up, care must be taken not to exceed the converter's maximum allowable output power. See previous section for a complete discussion of this requirement.

To decrease the output voltage (Fig. D), a trim resistor, R_{T-DECR} , should be connected between the TRIM (Pin 6) and SENSE(-) (Pin 5), with a value of:

$$R_{T-DECR} = \frac{511}{|\Delta|} - 10.22 \text{ [k}\Omega\text{]}$$

where,

R_{T-DECR} = Required value of trim-down resistor [k Ω]

and Δ is as defined above.

Note: The above equations for calculation of trim resistor values match those typically used in conventional industry-standard quarter bricks. For more information, see Application Note 103.

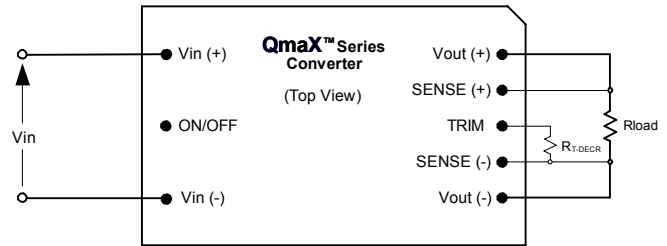

Fig. D: Configuration for decreasing output voltage.

Trimming/sensing beyond 110% of the rated output voltage is not an acceptable design practice, as this condition could cause unwanted triggering of the output over-voltage protection (OVP) circuit. The designer should ensure that the difference between the voltages across the converter's output pins and its sense pins does not exceed 10% of $V_{OUT(NOM)}$, or:

$$[V_{OUT(+)} - V_{OUT(-)}] - [V_{SENSE(+)} - V_{SENSE(-)}] \leq V_{O-NOM} \times 10\% \text{ [V]}$$

This equation is applicable for any condition of output sensing and/or output trim.

Protection Features

Input Under-Voltage Lockout

QM48T50015 DC-DC Converter Data Sheet

36-75 VDC Input; 1.5 VDC @ 50A Output



Input under-voltage lockout is standard with this converter. The converter will shut down when the input voltage drops below a pre-determined voltage.

The input voltage must be typically 34 V for the converter to turn on. Once the converter has been turned on, it will shut off when the input voltage drops below 31 V. This feature is beneficial in preventing deep discharging of batteries used in telecom applications.

Output Over-Current Protection (OCP)

The converter is protected against over-current or short circuit conditions. Upon sensing an over-current condition, the converter will switch to constant current operation and thereby begin to reduce output voltage. When the output voltage drops below 60% of the nominal value of output voltage, the converter will shut down.

Once the converter has shut down, it will attempt to restart nominally every 100 ms with a typical 1-2% duty cycle. The attempted restart will continue indefinitely until the overload or short circuit conditions are removed or the output voltage rises above 60% of its nominal value.

Output Over-Voltage Protection (OVP)

The converter will shut down if the output voltage across Vout(+) (Pin 8) and Vout(-) (Pin 4) exceeds the threshold of the OVP circuitry. The OVP circuitry contains its own reference, independent of the output voltage regulation loop. Once the converter has shut down, it will attempt to restart every 100 ms until the OVP condition is removed.

Over-Temperature Protection (OTP)

The converter will shut down under an over-temperature condition to protect itself from overheating caused by operation outside the thermal derating curves, or operation in abnormal conditions such as system fan failure. After the converter has cooled to a safe operating temperature, it will automatically restart.

Safety Requirements

The converters meet North American and International safety regulatory requirements per UL60950 and EN60950. Basic Insulation is provided between input and output. To comply with safety agencies requirements, an input line fuse must be used external to the converter. A 5-A fuse is recommended for use with this product.

Modules are UL approved for maximum fuse rating of 15-A. To protect a group of modules with a single fuse, the rating can be increased from the recommended values above.

Electromagnetic Compatibility (EMC)

EMC requirements must be met at the end-product system level, as no specific standards dedicated to EMC characteristics of board mounted component dc-dc converters exist. However, Power-One tests its converters to several system level standards, primary of which is the more stringent EN55022, *Information technology equipment - Radio disturbance characteristics - Limits and methods of measurement*.

Effective internal LC differential filter significantly reduces input reflected ripple current, and improves EMC.

With the addition of a simple external filter, all versions of the **QmaX™ Series** of converters pass the requirements of Class B conducted emissions per EN55022 and FCC, and meet at a minimum, Class A radiated emissions per EN 55022 and Class B per FCC Title 47CFR, Part 15-J. Please contact Power-One Applications Engineering for details of this testing.

Characterization

General Information

The converter has been characterized for many operational aspects, to include thermal derating (maximum load current as a function of ambient temperature and airflow) for vertical and horizontal mounting, efficiency, start-up and shutdown parameters, output ripple and noise, transient response to load step-change, overload and short circuit.

The following pages contain specific plots or waveforms associated with the converter. Additional comments for specific data are provided below.

Test Conditions

All data presented were taken with the converter soldered to a test board, specifically a 0.060" thick printed wiring board (PWB) with four layers. The top and bottom layers were not metalized. The two inner layers, comprising two-ounce copper, were used to provide traces for connectivity to the converter.

The lack of metalization on the outer layers as well as the limited thermal connection ensured that heat transfer from the converter to the PWB was minimized. This provides a

QM48T50015 DC-DC Converter Data Sheet

36-75 VDC Input; 1.5 VDC @ 50A Output



worst-case but consistent scenario for thermal derating purposes.

All measurements requiring airflow were made in Power-One's vertical and horizontal wind tunnel facilities using Infrared (IR) thermography and thermocouples for thermometry.

Ensuring components on the converter do not exceed their ratings is important to maintaining high reliability. If one anticipates operating the converter at or close to the maximum loads specified in the derating curves, it is prudent to check actual operating temperatures in the application. Thermographic imaging is preferable; if this capability is not available, then thermocouples may be used. Power-One recommends the use of AWG #40 gauge thermocouples to ensure measurement accuracy. Careful routing of the thermocouple leads will further minimize measurement error. Refer to Figure H for optimum measuring thermocouple location.

Thermal Derating

Load current vs. ambient temperature and airflow rates are given in Fig.1 and Fig. 2 for vertical and horizontal converter mounting. Ambient temperature was varied between 25°C and 85°C, with airflow rates from 30 to 500 LFM (0.15 to 2.5 m/s).

For each set of conditions, the maximum load current was defined as the lowest of:

- (i) The output current at which any FET junction temperature does not exceed a maximum specified temperature (120°C) as indicated by the thermographic image, or
- (ii) The nominal rating of the converter (50 A).

During normal operation, derating curves with maximum FET temperature less or equal to 120°C should not be exceeded. Temperature on the PCB at the thermocouple location shown in Fig. H should not exceed 118°C in order to operate inside the derating curves.

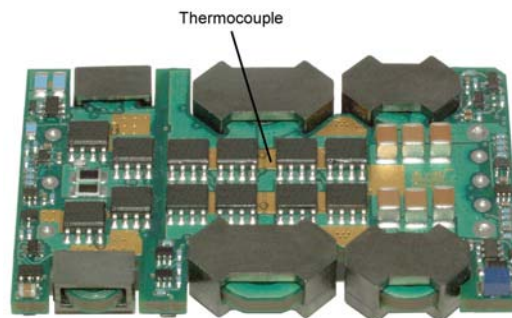

Fig. H: Location of the thermocouple for thermal testing.

Efficiency

Fig. 3 shows the efficiency vs. load current plot for ambient temperature of 25°C, airflow rate of 300 LFM (1.5 m/s) with vertical mounting and input voltages of 36 V, 48 V and 72 V.

Power Dissipation

Fig. 4 shows the power dissipation vs. load current plot for $T_a = 25^\circ\text{C}$, airflow rate of 300 LFM (1.5 m/s) with vertical mounting and input voltages of 36 V, 48 V and 72 V.

Start-up

Output voltage waveforms, during the turn-on transient using the ON/OFF pin for full rated load currents (resistive load) are shown without and with external load capacitance in Fig. 5 and Fig. 6, respectively.

Ripple and Noise

Fig. 8 shows the output voltage ripple waveform, measured at full rated load current with a 10 μF tantalum and 1 μF ceramic capacitor across the output. Note that all output voltage waveforms are measured across a 1 μF ceramic capacitor.

The input reflected ripple current waveforms are obtained using the test setup shown in Fig 9. The corresponding waveforms are shown in Fig. 10 and Fig. 11.



Start-up Information (using negative ON/OFF)

Scenario #1: Initial Start-up From Bulk Supply

ON/OFF function enabled, converter started via application of V_{IN} . See Figure E.

Time	Comments
t_0	ON/OFF pin is ON; system front end power is toggled on, V_{IN} to converter begins to rise.
t_1	V_{IN} crosses Under-Voltage Lockout protection circuit threshold; converter enabled.
t_2	Converter begins to respond to turn-on command (converter turn-on delay).
t_3	Converter V_{OUT} reaches 100% of nominal value.

For this example, the total converter start-up time ($t_3 - t_1$) is typically 4 ms.

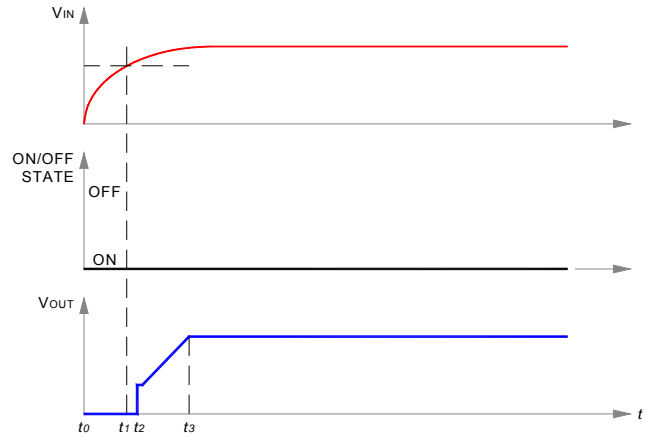

Fig. E: Start-up scenario #1.

Scenario #2: Initial Start-up Using ON/OFF Pin

With V_{IN} previously powered, converter started via ON/OFF pin. See Figure F.

Time	Comments
t_0	V_{INPUT} at nominal value.
t_1	Arbitrary time when ON/OFF pin is enabled (converter enabled).
t_2	End of converter turn-on delay.
t_3	Converter V_{OUT} reaches 100% of nominal value.

For this example, the total converter start-up time ($t_3 - t_1$) is typically 4 ms.

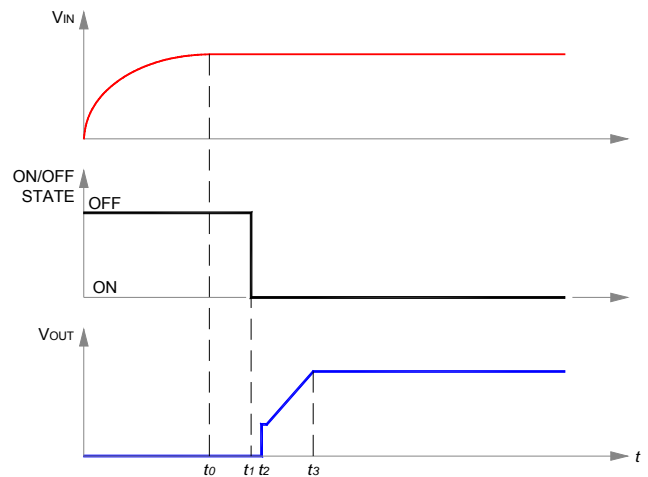

Fig. F: Start-up scenario #2.

Scenario #3: Turn-off and Restart Using ON/OFF Pin

With V_{IN} previously powered, converter is disabled and then enabled via ON/OFF pin. See Figure G.

Time	Comments
t_0	V_{IN} and V_{OUT} are at nominal values; ON/OFF pin ON.
t_1	ON/OFF pin arbitrarily disabled; converter output falls to zero; turn-on inhibit delay period (100 ms typical) is initiated, and ON/OFF pin action is internally inhibited.
t_2	ON/OFF pin is externally re-enabled. If $(t_2 - t_1) \leq 100$ ms, external action of ON/OFF pin is locked out by start-up inhibit timer. If $(t_2 - t_1) > 100$ ms, ON/OFF pin action is internally enabled.
t_3	Turn-on inhibit delay period ends. If ON/OFF pin is ON, converter begins turn-on; if off, converter awaits ON/OFF pin ON signal; see Figure F.
t_4	End of converter turn-on delay.
t_5	Converter V_{OUT} reaches 100% of nominal value.

For the condition, $(t_2 - t_1) \leq 100$ ms, the total converter start-up time ($t_5 - t_2$) is typically 104 ms. For $(t_2 - t_1) > 100$ ms, start-up will be typically 4 ms after release of ON/OFF pin.

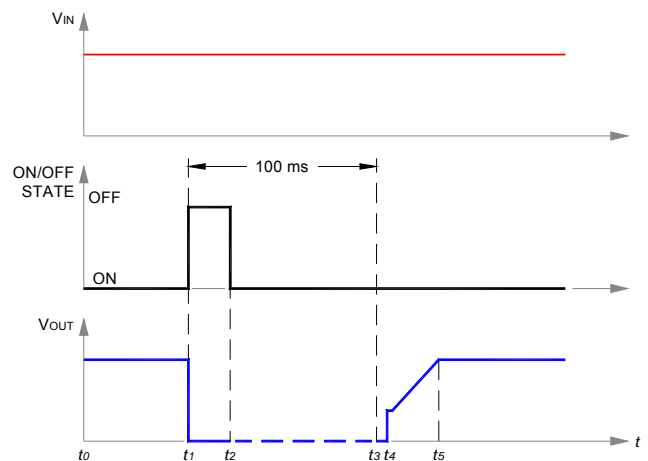

Fig. G: Start-up scenario #3.

QM48T50015 DC-DC Converter Data Sheet

36-75 VDC Input; 1.5 VDC @ 50A Output

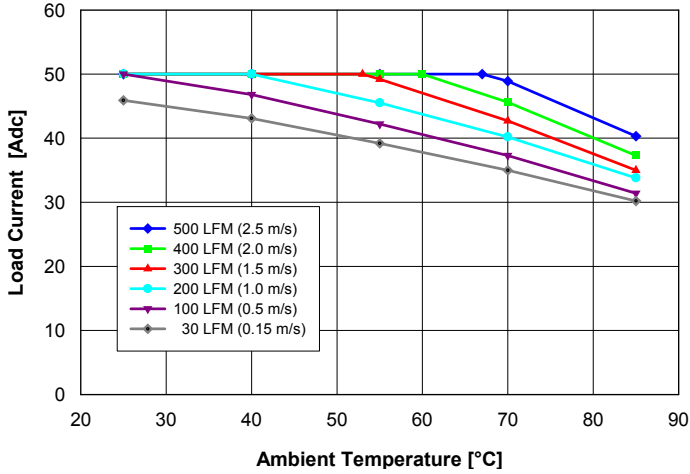

Fig. 1: Available load current vs. ambient air temperature and airflow rates for **QM48T50015** converter with **D** height pins mounted vertically with air flowing from pin 3 to pin 1, MOSFET temperature $\leq 120^{\circ}\text{C}$, $V_{in} = 48\text{ V}$.

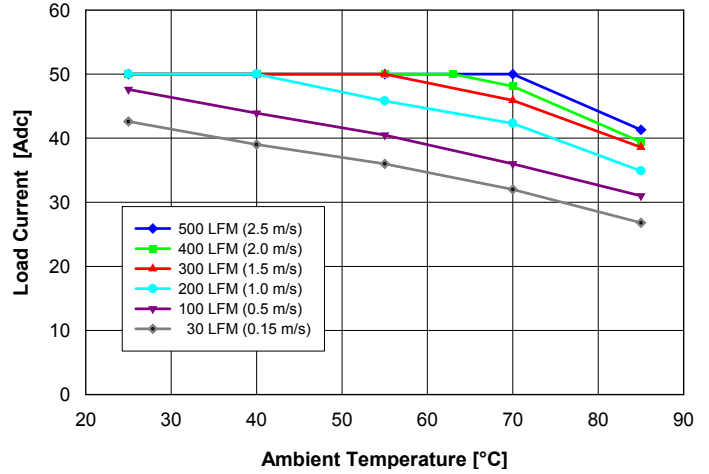

Fig. 2: Available load current vs. ambient air temperature and airflow rates for **QM48T50015** converter with **D** height pins mounted horizontally with air flowing from pin 3 to pin 1, MOSFET temperature $\leq 120^{\circ}\text{C}$, $V_{in} = 48\text{ V}$.

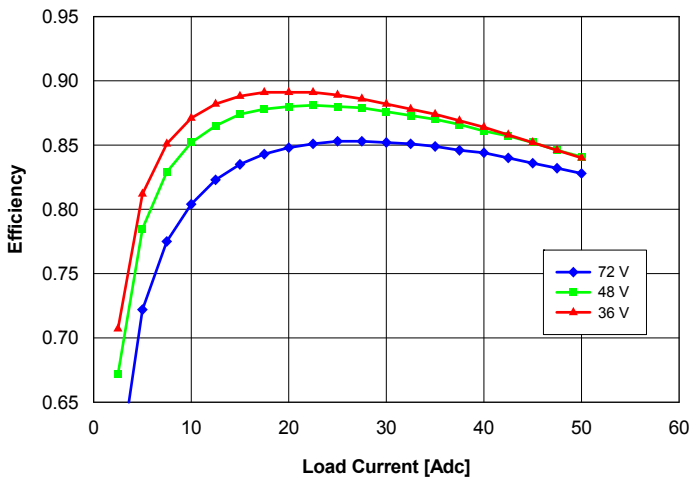

Fig. 3: Efficiency vs. load current and input voltage for converter mounted vertically with air flowing from pin 3 to pin 1 at a rate of 300 LFM (1.5 m/s) and $T_a = 25^{\circ}\text{C}$.

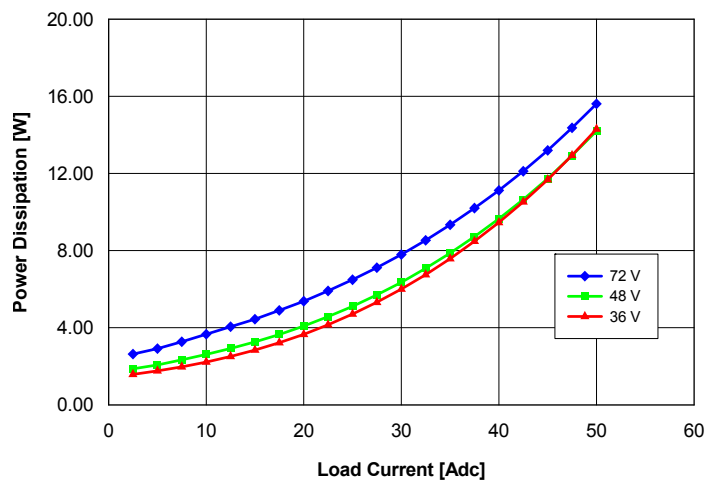

Fig. 4: Power dissipation vs. load current and input voltage for converter mounted vertically with air flowing from pin 3 to pin 1 at a rate of 300 LFM (1.5 m/s) and $T_a = 25^{\circ}\text{C}$.

QM48T50015 DC-DC Converter Data Sheet
36-75 VDC Input; 1.5 VDC @ 50A Output

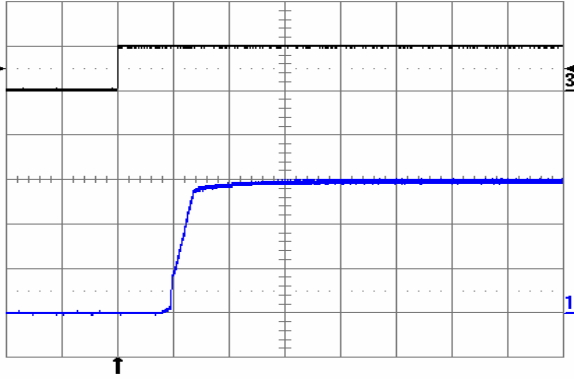

Fig. 5: Turn-on transient at full rated load current (resistive) with no output capacitor at $V_{in} = 48\text{ V}$, triggered via ON/OFF pin. Top trace: ON/OFF signal (5 V/div.). Bottom trace: output voltage (0.5 V/div.) Time scale: 2 ms/div.

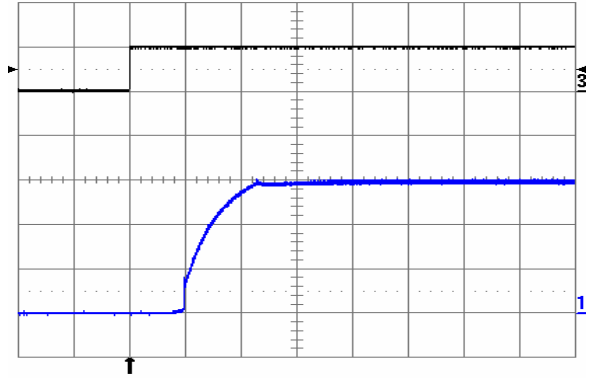

Fig. 6: Turn-on transient at full rated load current (resistive) plus 40,000 μF at $V_{in} = 48\text{ V}$, triggered via ON/OFF pin. Top trace: ON/OFF signal (5 V/div.). Bottom trace: output voltage (0.5 V/div.). Time scale: 2 ms/div.

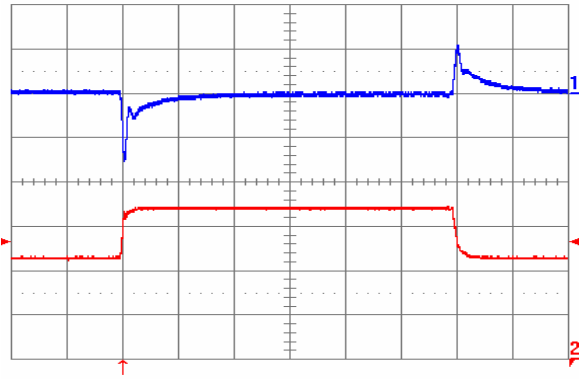

Fig. 7: Output voltage response to load current step-change (25 A – 37.5 A – 25 A) at $V_{in} = 48\text{ V}$. Top trace: output voltage (100 mV/div.). Bottom trace: load current (10 A/div). Current slew rate: 1 A/ μs . $C_o = 470\text{ }\mu\text{F}$ tantalum + 1 μF ceramic. Time scale: 0.2 ms/div.

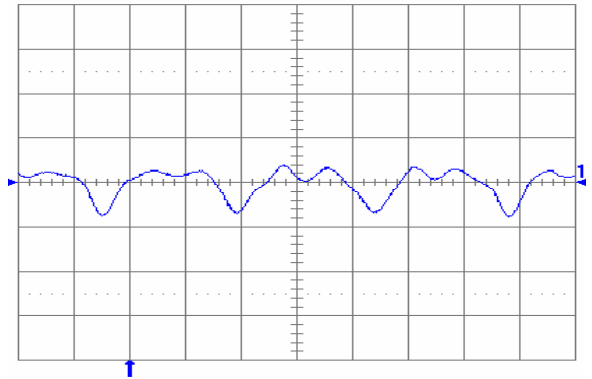

Fig. 8: Output voltage ripple (20 mV/div.) at full rated load current into a resistive load with $C_o = 10\text{ }\mu\text{F}$ tantalum + 1 μF ceramic and $V_{in} = 48\text{ V}$. Time scale: 1 μs /div.

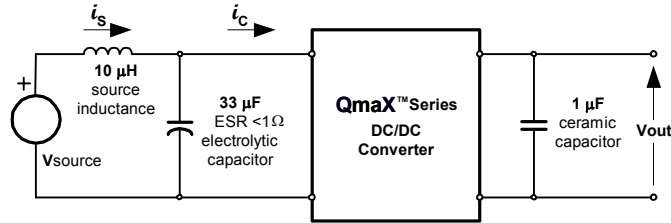

Fig. 9: Test Set-up for measuring input reflected ripple currents, i_c and i_s .

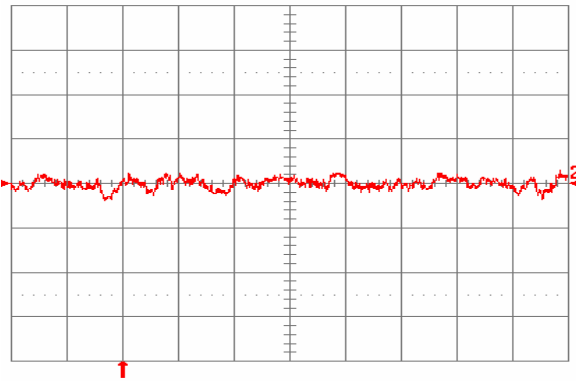

Fig. 10: Input reflected ripple current, i_s (10 mA/div), measured through 10 μ H at the source at full rated load current and $V_{in} = 48$ V. Refer to Fig. 9 for test setup. Time scale: 1 μ s/div.

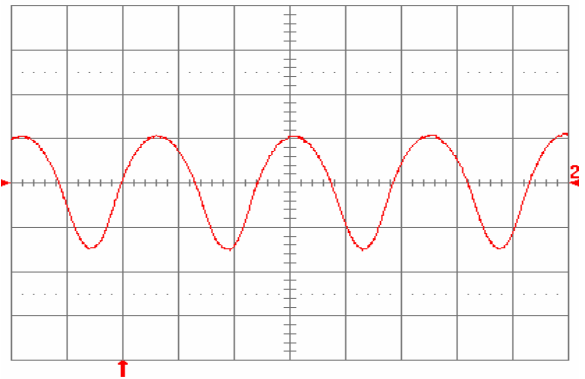

Fig. 11: Input reflected ripple current, i_c (100 mA/div), measured at input terminals at full rated load current and $V_{in} = 48$ V. Refer to Fig. 9 for test setup. Time scale: 1 μ s/div.

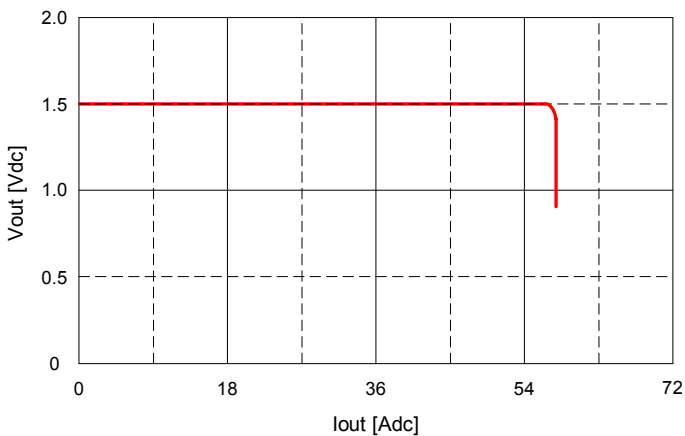

Fig. 12: Output voltage vs. load current showing current limit point and converter shutdown point. Input voltage has almost no effect on current limit characteristic.

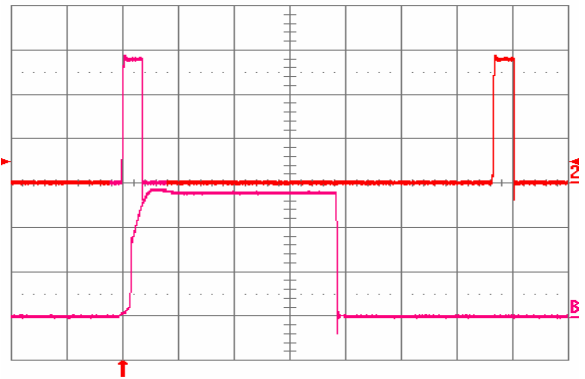
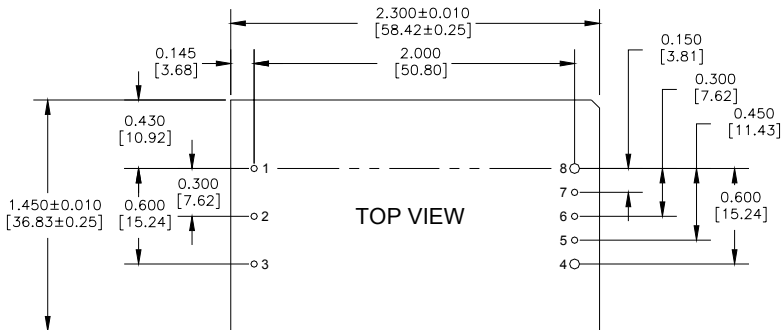

Fig. 13: Load current (top trace, 20 A/div, 20 ms/div) into a 10 m Ω short circuit during restart, at $V_{in} = 48$ V. Bottom trace (20 A/div, 1 ms/div) is an expansion of the on-time portion of the top trace.



Physical Information



Pin Connections	
Pin #	Function
1	Vin (+)
2	ON/OFF
3	Vin (-)
4	Vout (-)
5	SENSE(-)
6	TRIM
7	SENSE(+)
8	Vout (+)

- All dimensions are in inches [mm]
- Pins 1-3 and 5-7 are \varnothing 0.040" [1.02] with \varnothing 0.078" [1.98] shoulder
- Pins 4 and 8 are \varnothing 0.062" [1.57] without shoulder
- Pin Material: Brass
- Pin Finish: Tin/Lead over Nickel
- Converter Weight: 1.1 oz [31.5 g] typical

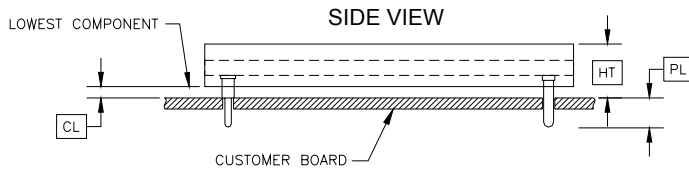

Height Option	HT (Maximum Height)	CL (Minimum Clearance)
	+0.000 [+0.00] -0.038 [-0.97]	+0.016 [+0.41] -0.000 [-0.00]
A	0.325 [8.26]	0.030 [0.77]
B	0.358 [9.09]	0.063 [1.60]
D	0.422 [10.72]	0.127 [3.23]

Pin Option	PL (Pin Length)
	\pm 0.005 [\pm 0.13]
A	0.188 [4.77]
B	0.145 [3.68]
C	0.110 [2.79]